

View from inside

- ① primary panel
- ② secondary panel

I - 3R

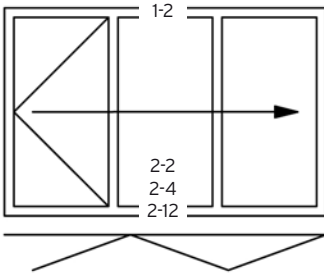

I - 5R

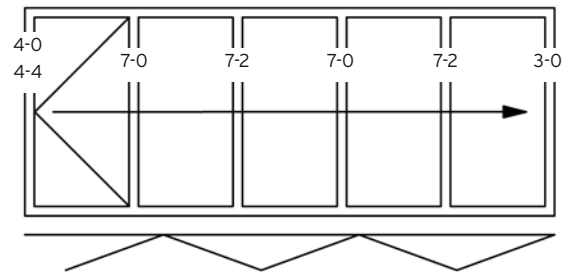

I - 4R

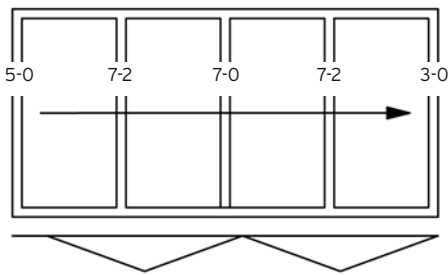

I - 4LR

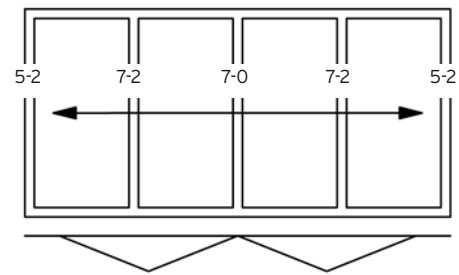

I - 2L 2R

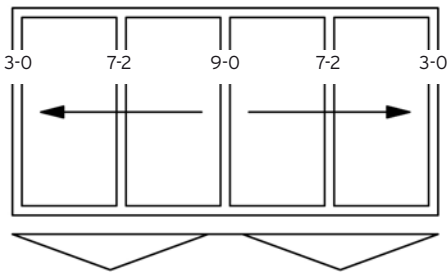

I - 2LR 2LR

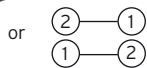
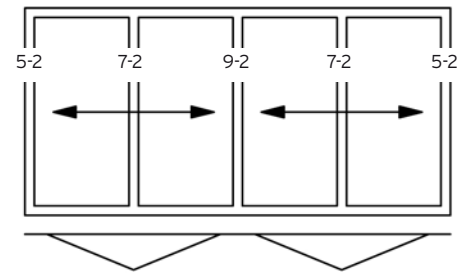

I - 1L 3R

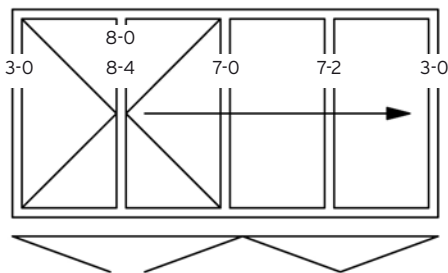

I - 1L 4LR Swing

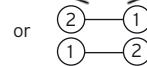
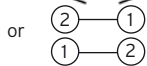
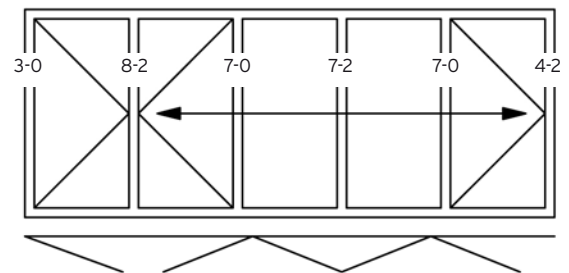

I - 2L 3R

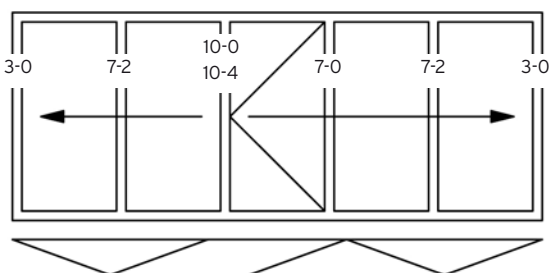

I - 2LR 3R

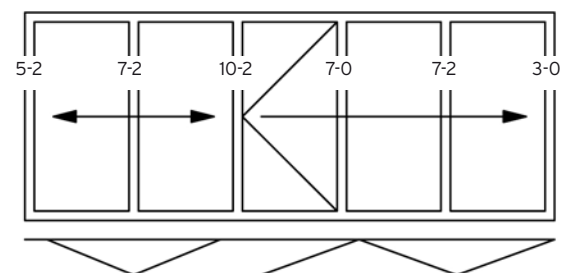

View from inside

A - 3R

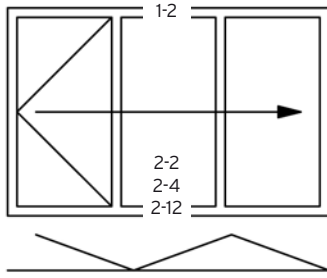

A - 5R

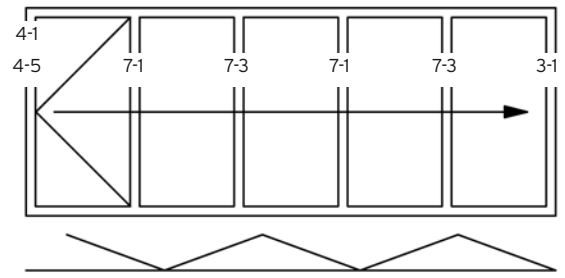

A - 4R

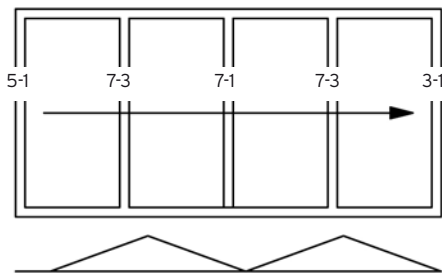

A - 4LR

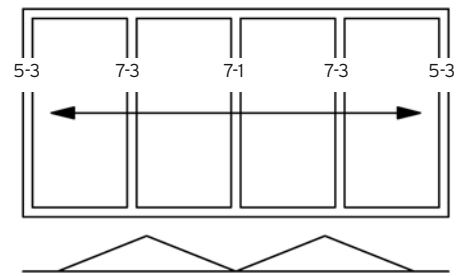

A - 2L 2R

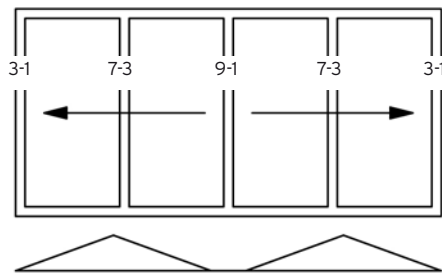

A - 2LR 2LR

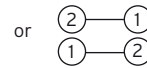
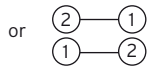
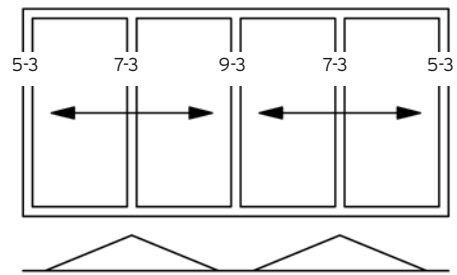

A - 1L 3R

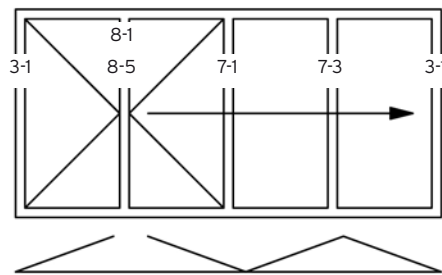

A - 1L 4LR Swing

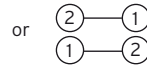
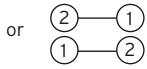
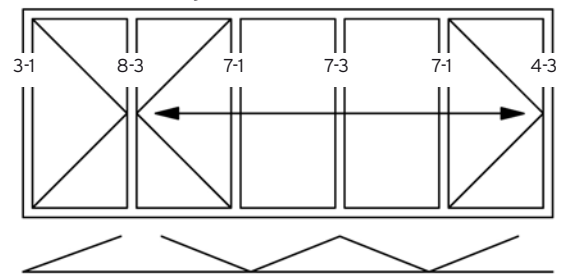

A - 2L 3R

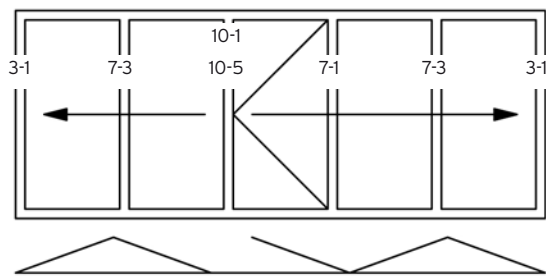

A - 2LR 3R

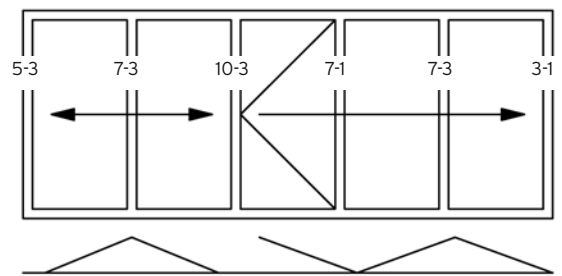

View from inside

Folding façade with transom

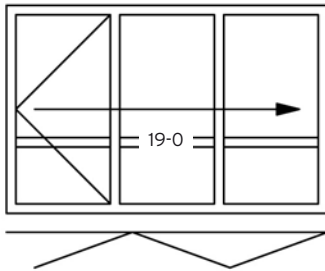

Folding façade with overhead panel

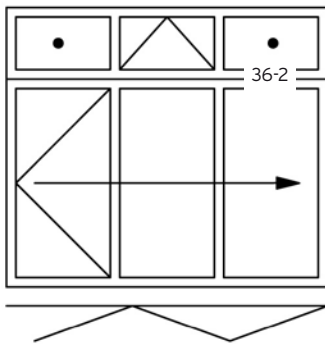

Folding façade on parapet

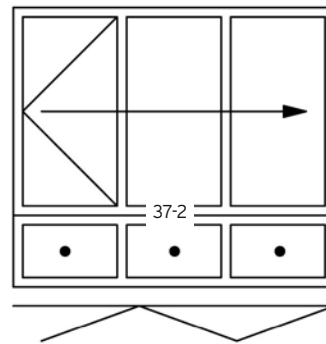

Folding façade with turn and tilt panel in the folding façade

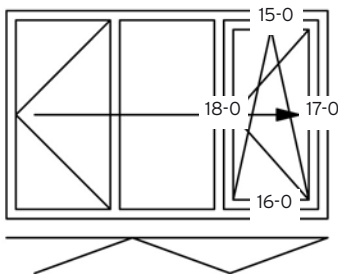

Folding façade with turn and tilt panel

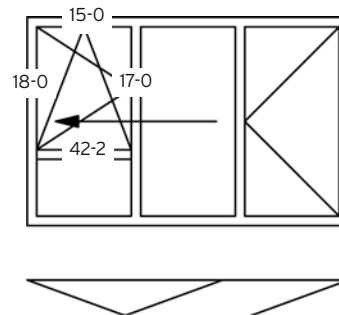

View from inside

A - 3L I - 3R

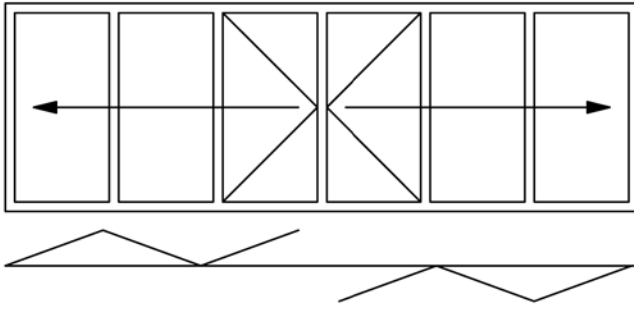

partly outswing,
partly inswing

A - LR - centre pivot

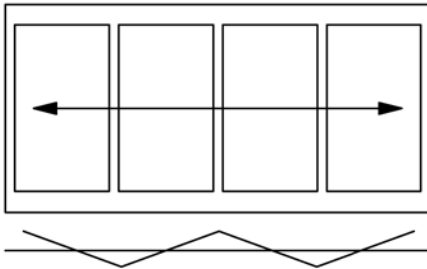

Floor plan examples:
In the case of an angled configuration
the design is adapted to the situation and
functional requirements.

I - 3L 3R

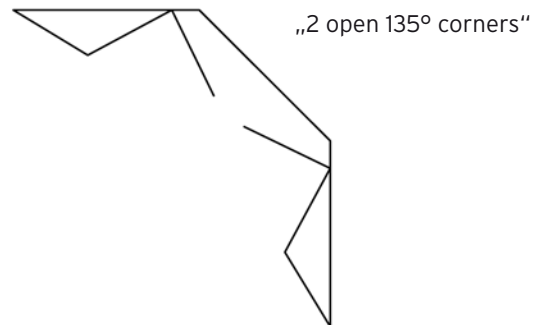
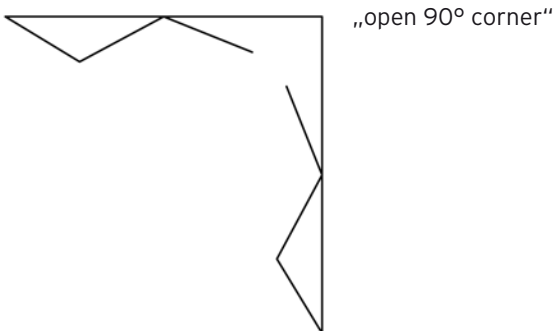
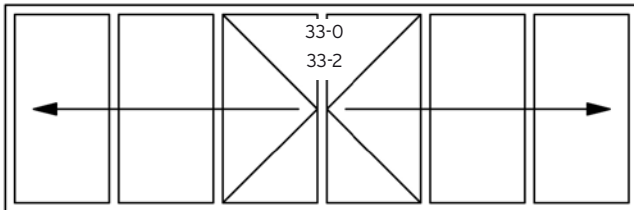

A - 4 x 2LR - segmented

