

View from inside

Straight configuration (plan view)

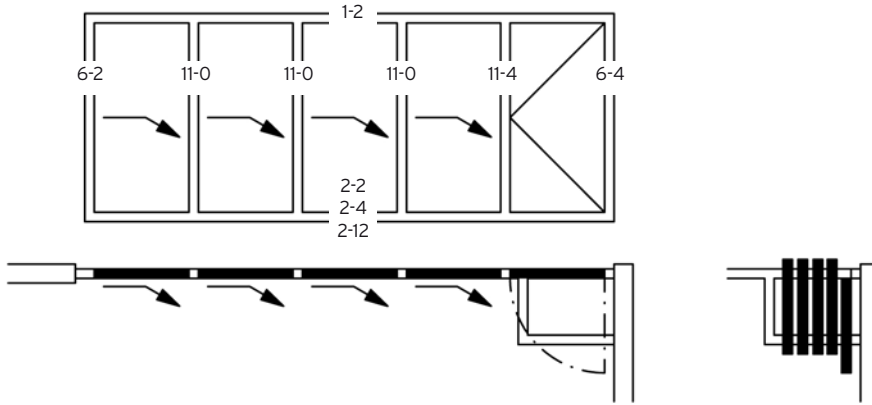

Segmented configuration (plan view)

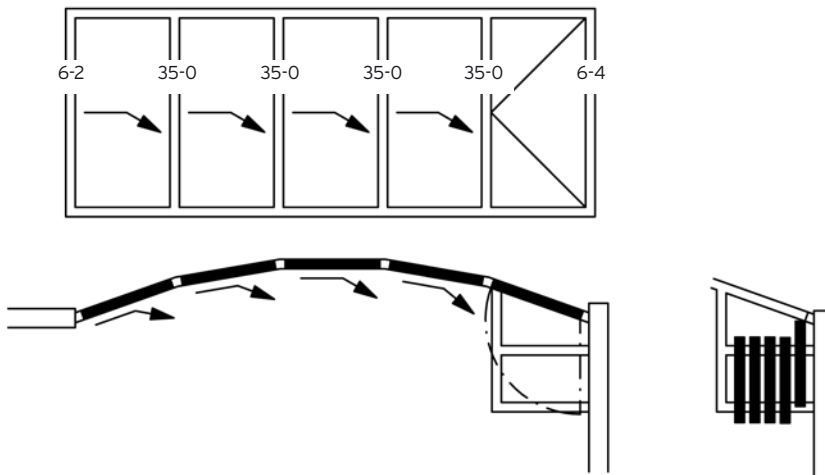

The models, plan views and stacking bays shown are examples from a much bigger variety of possible designs.

View from inside

Angled configuration (plan view)

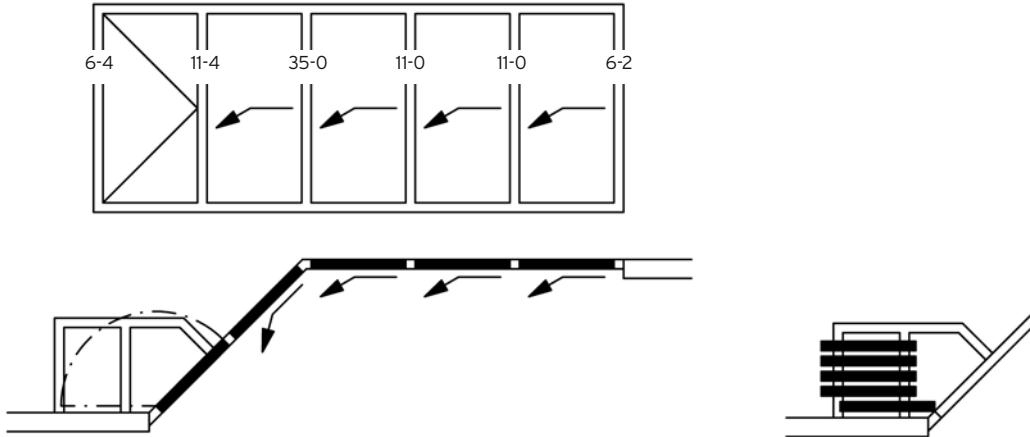

Right angle configuration (plan view)

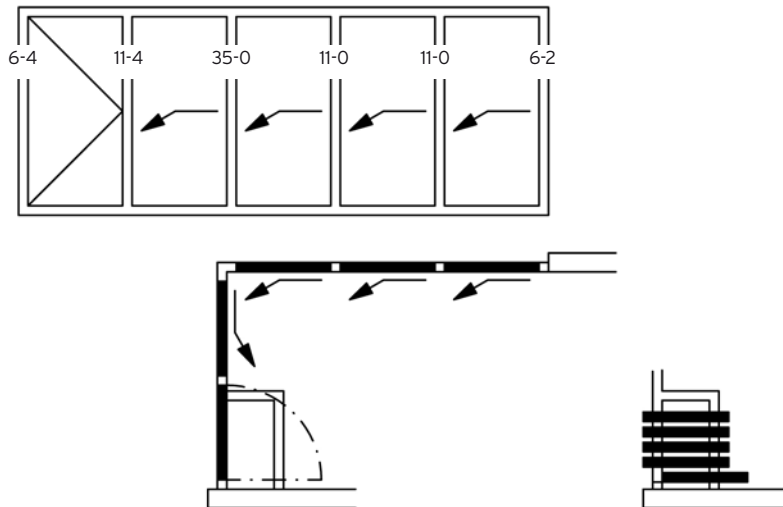

The models, plan views and stacking bays shown are examples from a much bigger variety of possible designs.

View from inside

S-shaped configuration (plan view)

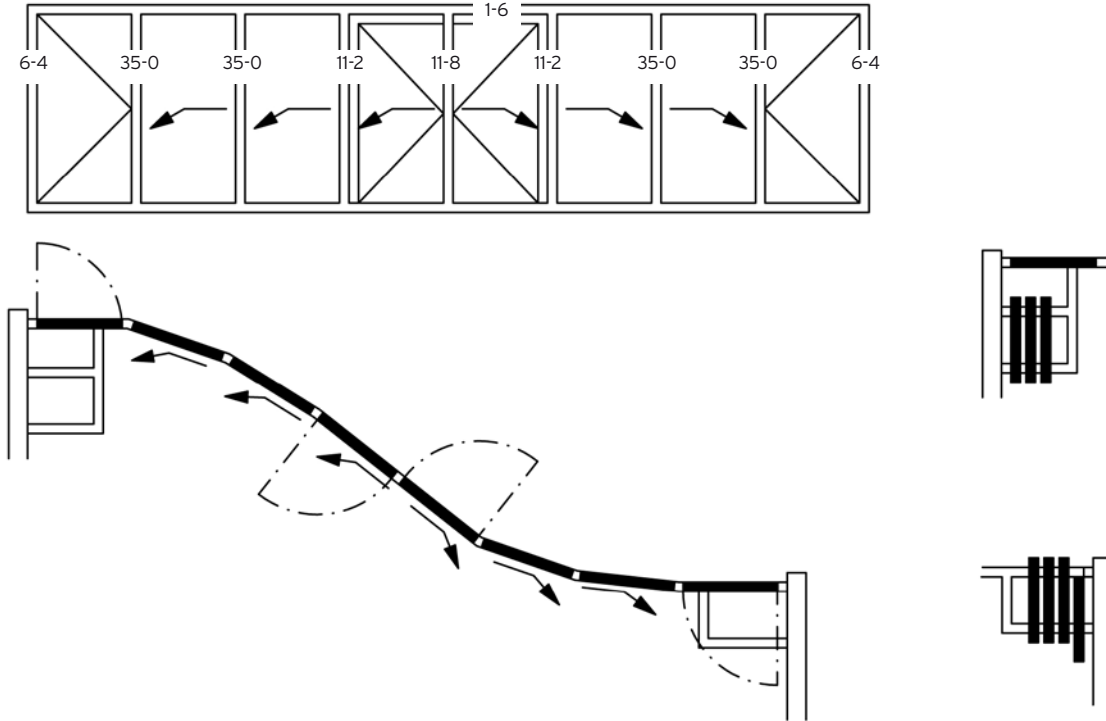

Straight configuration with stacking inside pocket

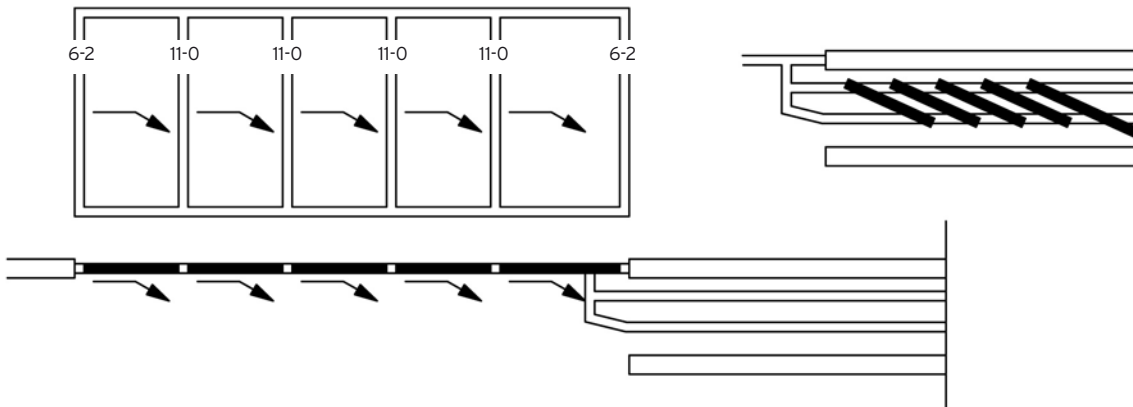

The models, plan views and stacking bays shown are examples from a much bigger variety of possible designs.

View from inside

HSW with panel with incorporated pass door and transom window

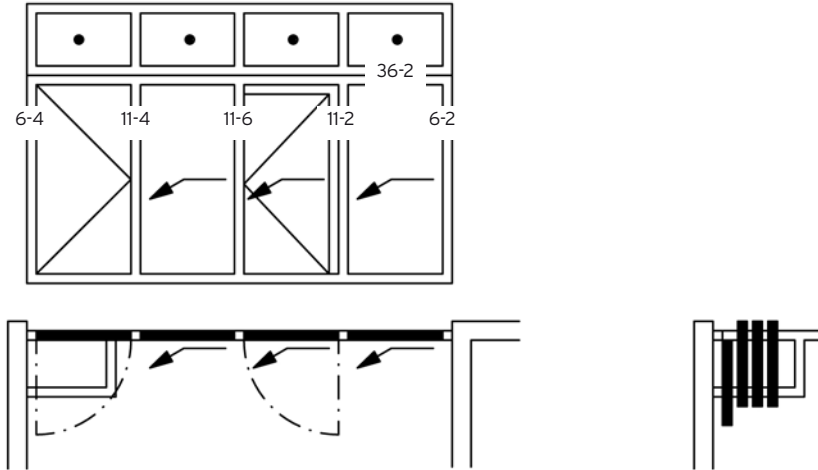

HSW with panel with incorporated pass door and transom rail

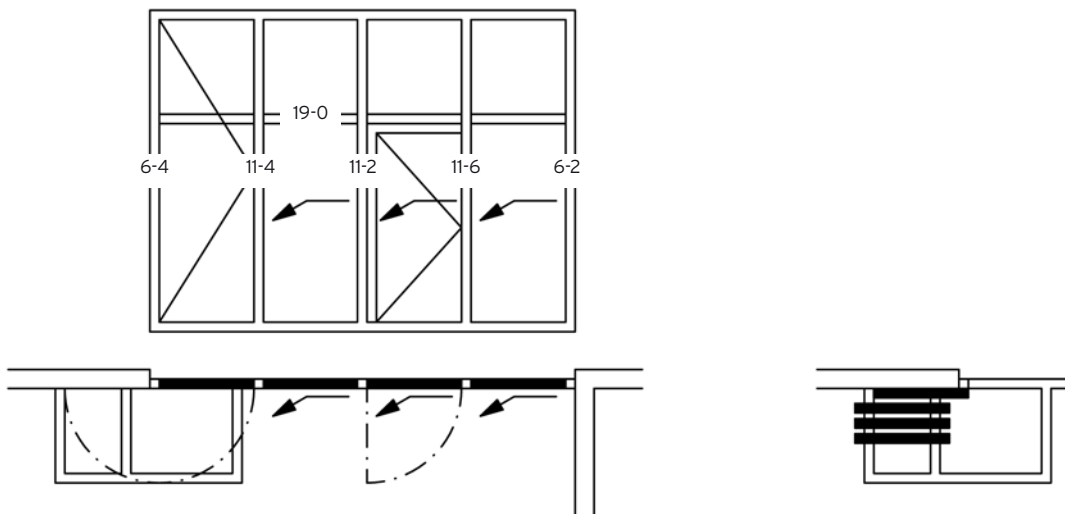

The models, plan views and stacking bays shown are examples from a much bigger variety of possible designs.

Examples for stacking bays

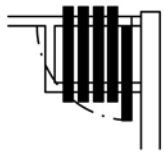

Stacking bay perpendicular to the track

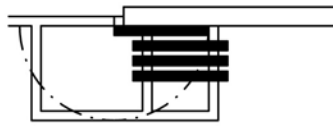

Stacking bay outside the plane of the opening on top of 180° turned swing panel

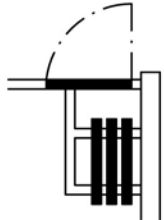

Stacking bay perpendicular to the track with swing panel opening out

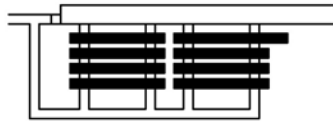

Dual stacking bay outside the plane of the opening

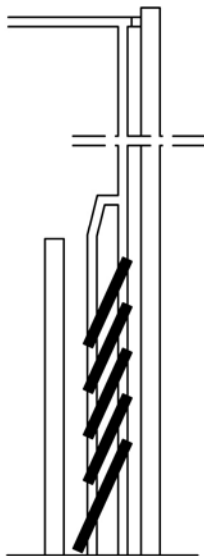

Stacking bay outside the plane of the opening

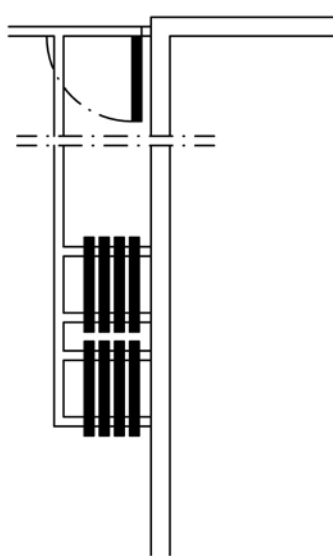

Dual stacking bay outside the plane of the opening

HSW Panel Options

Swing panel attached to side jamb

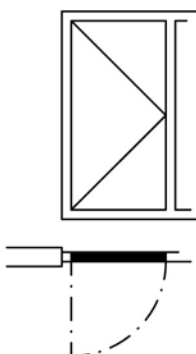

Sliding panel

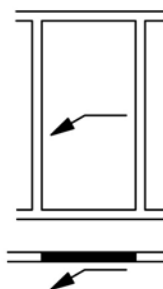

First sliding panel at turnout

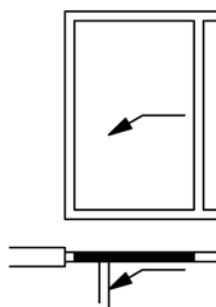

Incorporated swing panel

